

DETAIL OF MOUNTING BLOCK

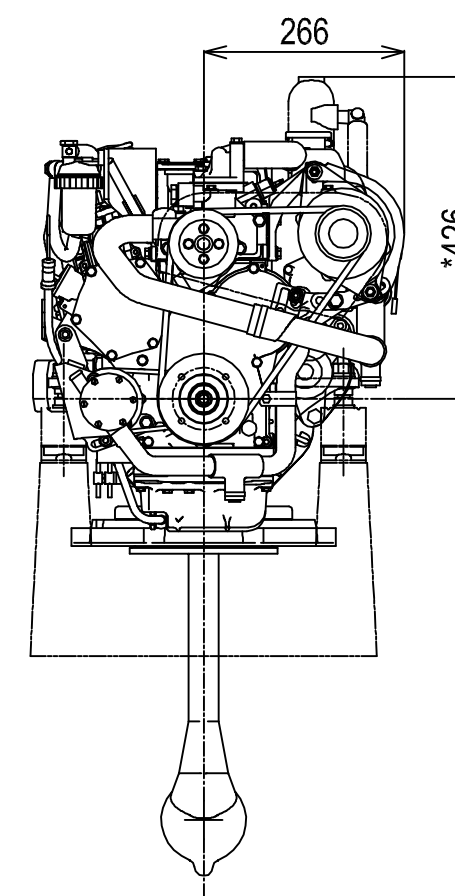

DIRECTION OF ROTATION

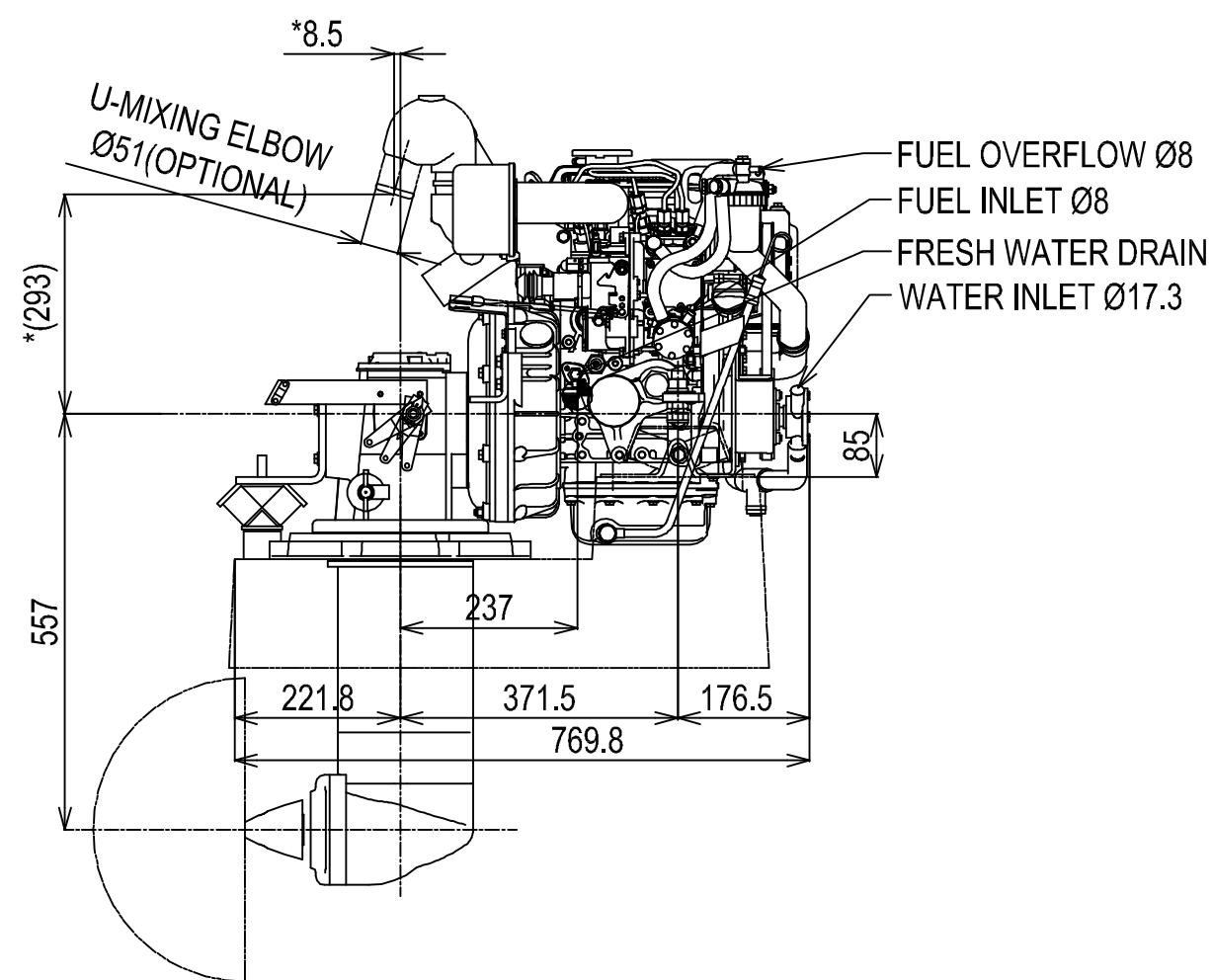
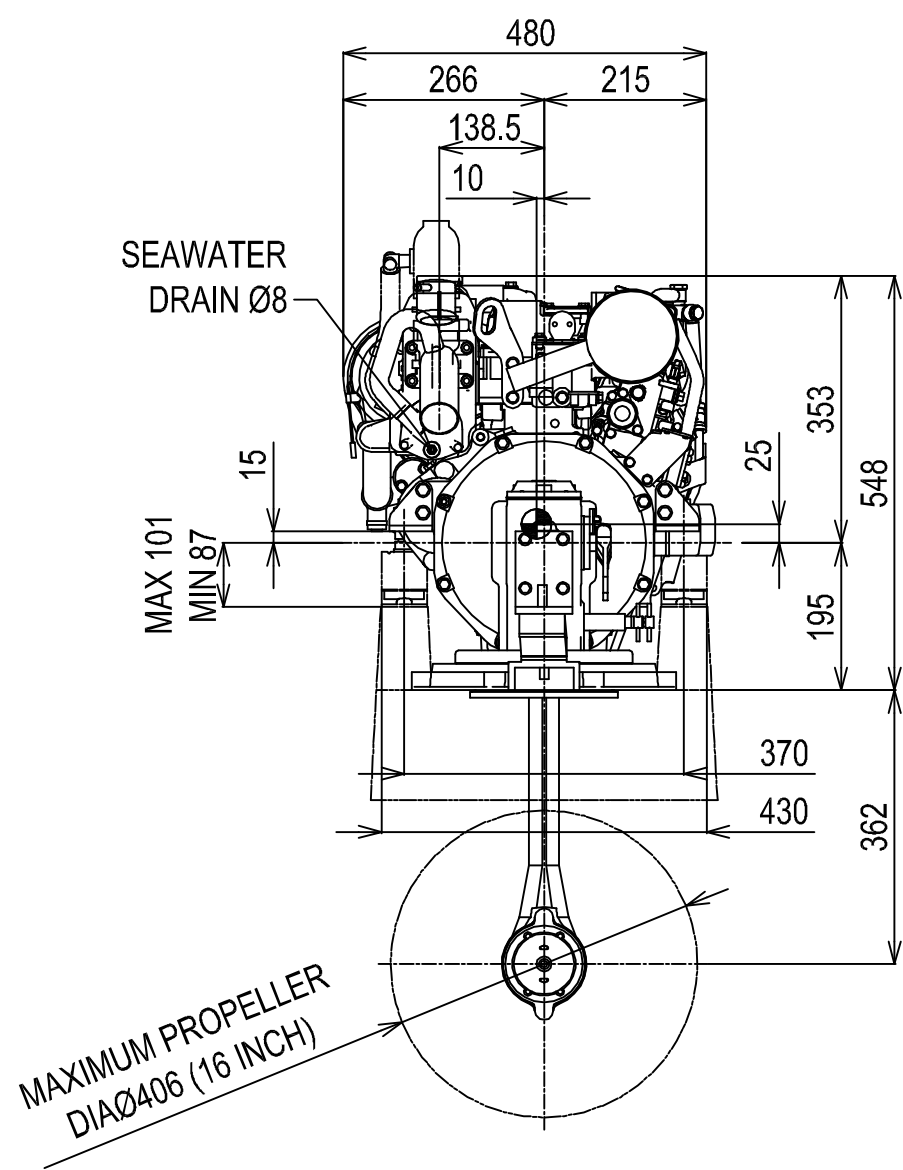
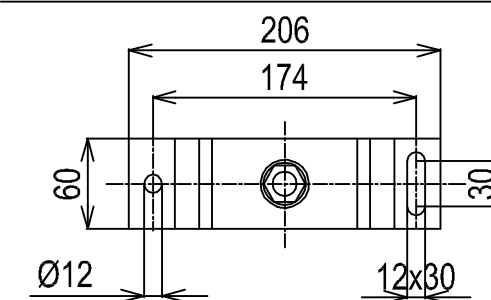
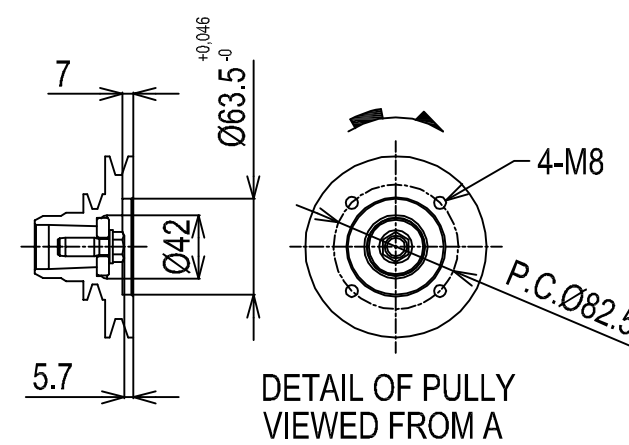

NOTE:

1. DWG. SHOWS MOUNTING BLOCKS AT ORIGINAL HEIGHT. ENGINE WEIGHT WILL COMPRESS BLOCKS BY 4.5 MM (APPROX).
2. MOUNTING BLOCKS ARE EQUIPPED FOR STANDARD ACCESSORY.
3. ● SHOWS THE CENTER OF GRAVITY.
4. FOR ADDITIONAL INSTALLATION INFORMATION AND SPECIFICATIONS PLEASE REFER TO THE YANMAR ENGINE INSTALLATION MANUAL

Series: YM	Engine: 2YM15xSD20	Release: R2010-01
Scale: 1:10	Date: 01-03-10	Dimensions: mm

